



## M30 Handheld Thermography Camera



The thermographic handheld camera is based on the thermal technology, specially designed for the needs of temperature measuring applications. People can quickly troubleshoot faults on-site.

### Key Features

- Thermal resolution: 384 x 288 (110 592 pixels)
- NETD : < 35mK (@ 25 °C, F#=1.0)
- Temperature measurement range : -20 °C - 550 °C (-4°F~1022°F)
- Accuracy: Max ( $\pm 2^{\circ}\text{C}/3.6^{\circ}\text{F}$ ,  $\pm 2\%$ ), for ambient temperature 15°C to 35°C (59°F to 95°F) and object temperature above 0°C (32°F)
- Measurement Presets: Center spot, Hot spot, Cold spot, User Preset Point/Line/Area
- Manual focus
- 25 Hz image frequency
- 3.5" LCD touch screen display

[www.Wavecom.com.au](http://www.Wavecom.com.au)

**South Australia**  
257 Grange Road  
Findon, SA 5023  
P: +61 08 8243 3500  
F: +61 08 8243 3501  
E: sales@wavecom.com.au

**Western Australia**  
Unit 2/17 Casino Street,  
Welshpool, WA 6016  
P: +61 08 9353 1943  
F: +61 08 9353 4319  
E: saleswa@wavecom.com.au

**Victoria**  
Mark Kennedy  
M: 0430 299 164  
P: +61 08 8243 3500  
F: +61 08 8243 3501  
E: salesvic@wavecom.com.au





## Specification

Thermal Module	
Image Sensor	Vanadium Oxide Uncooled Focal Plane Arrays
IR Resolution	384 × 288 (110 592 pixels)
Pixel Pitch	17 μm
Spectral Range	8 - 14 μm
NETD	< 35mK (@ 25 °C, F#=1.0)
Focal Length	10 mm
FOV (Field of View)	37.5° × 28.5 °
Image Frequency	25 Hz
Focus	Manual
IFOV (Spatial Resolution)	1.7mrad
Aperture	F1.0
Minimum Focus Distance	0.1 m (0.33 ft)
Optical Module	
Picture Resolution	Configurable: 2 MP, 5 MP, 8 MP
Video Resolution	640 × 480
Focus	Fixed
FOV	37.5° × 28.5 °
Image Display	
Display	640 × 480 Resolution, 3.5" LCD Touch Screen
Color Palettes	White Hot, Black Hot, Rainbow, Ironbow, Red Hot, Fusion, Rain
Digital Zoom	1x, 2x, 4x, 8x
Image Modes	Thermal/Optical/Fusion/PIP
PIP	Thermal Picture in Optical Picture
Fusion	Thermal Picture and Optical Picture Combined
Measurement and Analysis	
Object Temperature Range	-20 °C to 550 °C (-4 °F to 1022 °F)
Accuracy	Max (±2°C/3.6°F, ±2%), for ambient temperature 15°C to 35°C (59°F to 95°F) and object temperature above 0°C (32°F)
Measurement Presets	Center Spot, Hot Spot, Cold Spot, Off
Point	10 User Presets
Line	1 User Preset
Area	3 User Presets
High Temperature Alarm	Audible Warning
Color Alarm (Isotherm)	Above/Below/Interval/Insulation





<b>Storage</b>	
Storage Media	Removable Micro SD Card (64 GB)
Image Storage Capacity	120 000 Images
Image File Format	JPEG with Measurement Data Included
Video Storage Capacity	56 Hours
Video File Format	MP4
<b>Functions</b>	
Laser Pointer	Yes
Laser Type	Class II
LED Light	70 Lumens
Wi-Fi	802.11 a/ac/b/g/n (2.4 and 5 GHz)
Bluetooth	Bluetooth 4.2
Level/Span	Auto/Manual
Text Comment	Max 200 Characters
Voice Comment	Max 60 Seconds
<b>Power System</b>	
Power Supply	12 V DC/1.5A, 5V DC/2A (Charging via USB)
Power Consumption	4.6 W
Battery Type	Dismountable and Rechargeable Li-ion Battery
Battery Operating Time	4 Hours Continuous Running
<b>General</b>	
Menu Language	18 Languages English/German/French/Russian/Korean/Spanish/Portuguese/Italian/Japanese/Hungarian/Czech/Slovak/Polish/Romanian/Danish/Turkish/Traditional_Chinese/Arabic
Working Temperature Range	-20 °C to 50 °C (-4 °F to 122 °F)
Storage Temperature Range	-20 °C to 60 °C (-4 °F to 140 °F)
Protection Level	IP54
Drop Test Height	2 m (6.56 ft)
Interface	USB Type-C
Weight	Approx. 660 g (1.46 lb)
Dimension	244 mm × 100 mm × 104 mm (9.6 " × 3.9 " × 4.1 ")
Tripod Mounting	UNC ¼"-20





## Packing List

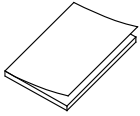

Quick Start Guide  
(x1)



Adapters (x4)

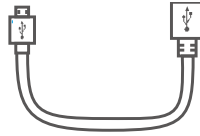

USB Cable (x1)



Power Adapter (x1)

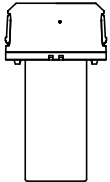

Battery (x2)

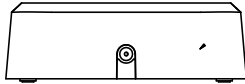

Charging Base (x1)

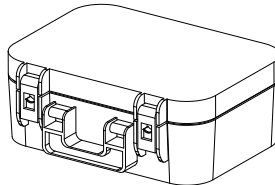

Box (x1)

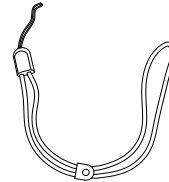

Wrist Strap (x1)

## Available model

HM-TP23-10VF/W-M30

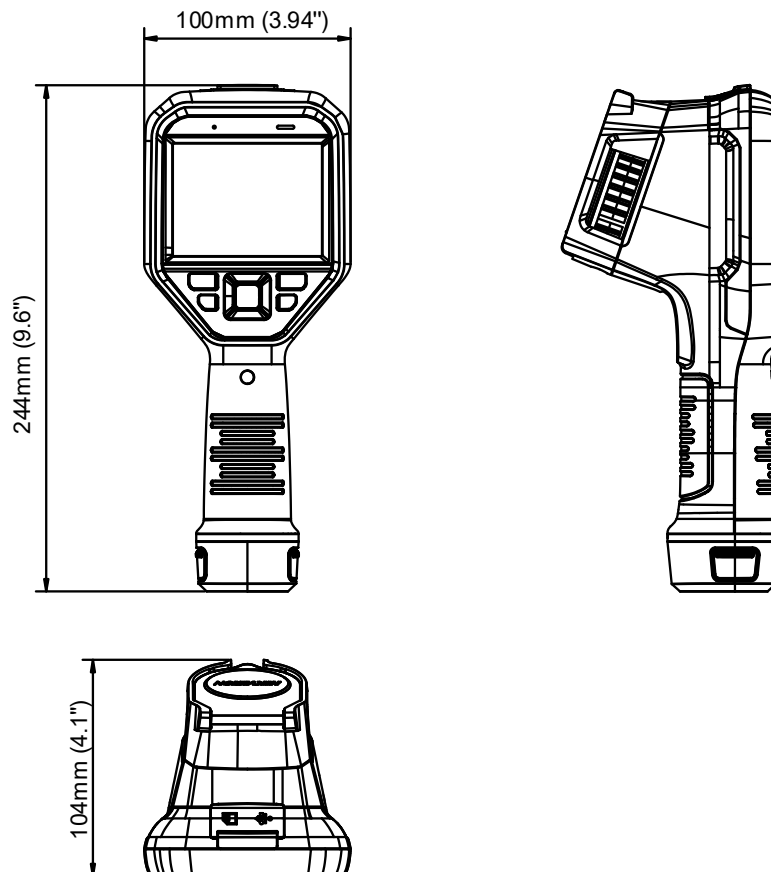

[www.Wavecom.com.au](http://www.Wavecom.com.au)

**South Australia**  
257 Grange Road  
Findon, SA 5023  
P: +61 08 8243 3500  
F: +61 08 8243 3501  
E: sales@wavecom.com.au

**Western Australia**  
Unit 2/17 Casino Street,  
Welshpool, WA 6016  
P: +61 08 9353 1943  
F: +61 08 9353 4319  
E: saleswa@wavecom.com.au

**Victoria**  
Mark Kennedy  
M: 0430 299 164  
P: +61 08 8243 3500  
F: +61 08 8243 3501  
E: salesvic@wavecom.com.au

